

WALL MOUNTED AIR CONDITIONER OWNER'S MANUAL



CA007U-15CR32(N)
16122000007895
2018.11.05



Read this manual carefully
before installing or operating your new
air conditioning unit. Make sure to save
this manual for future reference.

READ BEFORE OPERATING



This product has been determined to be in compliance with the Low Voltage Directive (2014/35/EU), and the Electromagnetic Compatibility Directive (2014/30/EU) of the European Union.

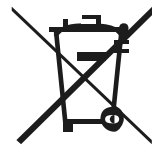

Correct Disposal of This Product (Waste Electrical & Electronic Equipment)

(When using this air conditioner in European countries, the following guidance must be followed)

- This marking shown on the product or its literature, indicates that waste electrical and electronic equipment (WEEE as in directive 2012/19/EC) should not be mixed with general household waste.

It is prohibited to dispose of this appliance in domestic household waste.

For disposal, there are several possibilities:

1. The municipality has established collection systems, where electronic waste can be disposed of at least free of charge to the user.
2. When buying a new product, the retailer will take back the old product at least free of charge.
3. The manufacture will take back the old appliance for disposal at least free of charge to the user.
4. As old products contain valuable resources, they can be sold to scrap metal dealers.

Wild disposal of waste in forests and landscapes endangers your health when hazardous substances leak into the ground-water and find their way into the food chain.



- Read this manual before using the product!
- Moving parts of appliance must be installed/located at the level not less than 2.3m from the floor.
- ELECTRICAL work may only be performed by authorized personnel and in accordance with national wiring standard. If the supply cord is damaged, it must be replaced by the manufacturer, its service agent or similarly qualified persons in order to avoid a hazard.
- Servicing shall only be performed as recommended by the equipment manufacturer.
- Maintenance and repair requiring the assistance of other skilled personnel shall be carried out under the supervision of the person competent in the use of flammable refrigerants.
- This appliance can be used by children aged from 8 years and above and persons with reduced physical, sensory or mental capabilities or lack of experience and knowledge if they have been given supervision or instruction concerning use of the appliance in a safe way and understand the hazards involved. Children shall not play with the appliance. Cleaning and user maintenance shall not be made by children without supervision (EN Standard requirements).
- This appliance is not intended for use by persons (including children) with reduced physical, sensory or mental capabilities, or lack of experience and knowledge, unless they have been given supervision or instruction concerning use of the appliance by a person responsible for their safety. Children should be supervised to ensure that they do not play with the appliance (IEC Standard requirements).

CONTENT

1. READ BEFORE OPERATING

1.1 Safety Precautions	03
1.2 Part Names	06

2. OPERATION

2.1 Operating Conditions	07
2.2 Manual Operation	07
2.3 How it Works	08
2.4 Directional Control	09
2.5 Special Functions	10

3. CARE

Care and Maintenance	11
----------------------------	----

4. TROUBLE SHOOTING

Guides, Tips and Cautions	13
---------------------------------	----

Indoor Unit	Outdoor Unit	Rated Voltage & Hz
42QHC009D8S*	38QHC009D8S*	220-240V~, 50/60Hz
42QHC012D8S*	38QHC012D8S*	
42QHC018D8S*	38QHC018D8S*	
42QHC024D8S*	38QHC024D8S*	



Caution: Risk of fire

1. READ BEFORE OPERATING

1.1 Safety Precautions

- Follow these instructions carefully to
 - avoid incorrect operation.
 - prevent personal injury or consequential damage.
 - optimise product life.
- The level of seriousness is classified as follows:

! WARNING
This symbol indicates the possibility of personnel injury or loss of life.

! CAUTION
This symbol indicates the possibility of property damage or serious consequences.

- Symbols used in this manual:



AVOID



COMPLY



WARNING

! The task of installing this product must only be performed by suitably qualified and appropriately experienced persons.

! Power plug must be securely inserted into the socket outlet if applicable.

⊘ Do not operate or stop the unit by connecting or disconnecting power plug.

⊘ Do not use extension cord or share the same power outlet with other

⊘ Do not use flammable gas or combustibles such as gasoline, benzene, thinner, etc. in the

⊘ Do not use a heating appliance in the conditioned space.

⊘ Children must be advised not to play with the air conditioner controls, moving parts and/or refrigeration and electrical connections.

⊘ Prolonged exposure to drafts may lead to muscular discomfort and dry eyes.

⊘ Operating with wet hands may result in electrical shock

! Turn off the unit if unusual smells, sounds or vibrations are noticed. Contact authorized dealer.

⊘ Do not attempt to repair, move or modify your air conditioner.

! Seek professional help – contact an authorized dealer.

1. READ BEFORE OPERATING

CAUTION

! Unplug the unit when unused for long periods

! The product is intended for human comfort ONLY

⊘ Do not climb or place objects on the unit.

⊘ Do not block air inlets or outlets. Poor performance, increased running costs and reduced product life will result.

! Disconnect BEFORE cleaning or servicing.

! Regularly inspect air filters and clean them if required.

! When cleaning, use water sparingly to prevent electrical shock.

! Never use strong detergents, solvents or abrasive polish on the product.

1.2 Part Names

■ Indoor

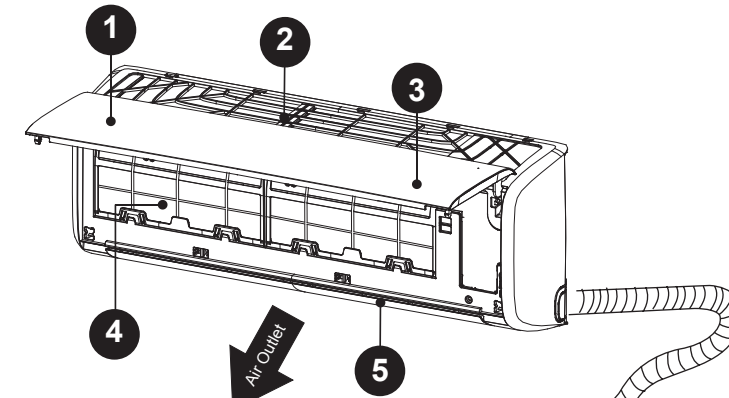

■ Outdoor

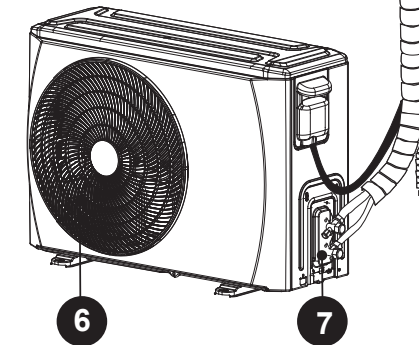

1. Front Panel
2. Air Inlet
3. Display
4. Air Filter
5. Louver
6. Grille
7. Service valve

Display symbol represent:

■ Display symbols



- 25 Shows setting temperature in normal operation.
- 25 Shows room temperature in FAN mode.
- ON Display it for three seconds when timer on is set, or activate Air purification*, Swing, Turbo and Silence* fuction.
- OFF Display it for three seconds when timer off is set, or cancel Air purification*, Swing, Turbo and Silence* fuction.
- dF Defrosting operation*
- cF Cold draft prevention*
- SC Self clean*
- FP 8°C heating mode *
- ECO When ECO fuction* is activated, the display illuminates in sequence as " E -- [-- 0 -- setting temperature -- E ... " in one second interval.
- WLAN function (only for the model with WLAN module)*

[*] Model dependent

Note: A guide on using the infrared remote controller refer to the remote controller manual

2. OPERATION

2.1 Operating Condition

		Indoor	Outdoor
Cooling operation	Upper limit	32°C DB	43°C DB (Fixed speed models)
			46°C DB (Inverter models)
	Lower limit	18°C DB	52°C DB (High ambient models)
			18°C DB (Fix speed models)
Heating operation	Upper limit	27°C DB	24°C DB
			Lower limit
	-15°C DB (Inverter models)		

Note: DB - Dry Bulb

- Optimum performance will be achieved within these operating temperatures.
- When the unit operates above or below these conditions for a long time, system diagnostics may detect a malfunction and the unit will not operate properly.
- Room relative humidity - less than 80%. If the air conditioner operates outside this range, the surface of the air conditioner may attract condensation. Please set the air flow louver to its maximum angle and set HIGH fan mode.

2.2 Manual Operation

Manual operation is available to control the unit when your remote is unavailable.

ACCESS

Open the front panel by carefully lifting both ends at the same time.

Once lifted sufficiently, a click is heard and it becomes self-supporting.

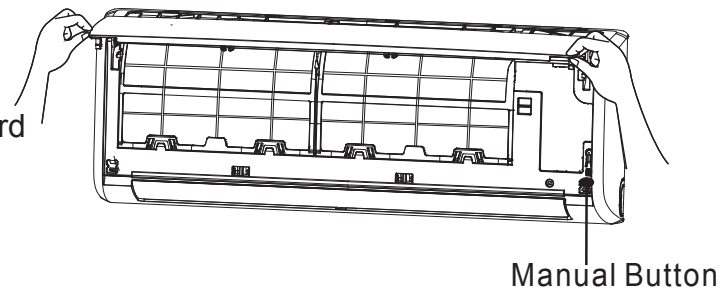

Manual Button

OPERATE

Press the manual button repeatedly to change modes as follows;

- Once = AUTO mode [heat, cool or fan and auto fan speed].
- Twice=COOLING mode [switches to AUTO mode after 30 minutes (mainly used for testing purpose)].
- Three times = OFF.

COMPLETE

Close the panel by firmly tugging downwards on both ends until it returns to its original position.

RESTORE

Using the remote controller will return the unit to normal operation.

2.3 How It Works!

Basic Operation Modes: AUTO / COOL / DRY / HEAT* / FAN

[*]Model dependent

AUTO Mode

- In this setting the system will automatically change modes and fan speed to the set temperature.
- In spring and autumn, closer temperature control may require COOL/HEAT mode changes.

DRY Mode

In this mode, priority is given to dehumidifying the air. Low fan speed and compressor cycling is used to achieve this and regulate room temperature.

SLEEP Mode

When selected, the set temperature will increase (cooling) or decrease (heating) by 1°C per hour for the first 2 hours. Thereafter it keeps this new temperature for 5 hours before switching off automatically. For some units, it keeps running with this new temperature all the time until you adjust it.

This operation saves energy and improves night time comfort by synchronising with the body's metabolism.

ECO Mode*

ECO mode can be activated at cooling mode for energy saving. When selected, the unit will automatically regular the fan speed and compressor rotation. It provides you the same comfort with minimum power consumption in 8 hours running time.

Hints For Economical Operation

- Adjust the temperature to achieve moderate comfort levels.
- Excessively low or high temperatures waste energy.
- Improve performance by keeping windows and doors closed.
- Limit energy usage [run time] by using the TIMER function.

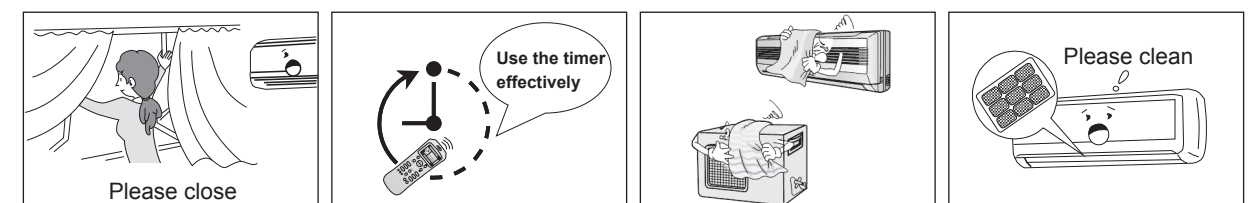
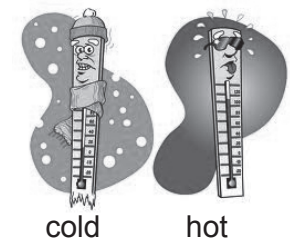

- Do not block air inlets or outlets. It will cause poor performance, increased running costs and reduced product life.
- Inspect the air filters periodically, and clean them when needed.

2. OPERATION

2.4 Directional Control

Adjusting vertical air flow

- Press “AIR DIRECTION” on remote controller to adjust vertical air flow direction. The louver position moves slightly each time the button is pressed.
 - Press “SWING” to engage continuous louver motion.
- Note: Please refer to the REMOTE CONTROLLER MANUAL for

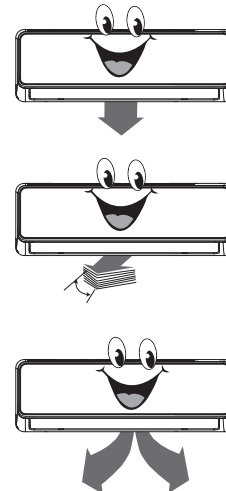

Adjusting horizontal air flow

Step 1

ISOLATE the unit at the MAIN switch (or unplug)

Step 2

Pull horizontal louver downwards using both hands.

Step 3

Identify the lever/s as indicated.

[On uppermost part of air outlet and linked to recessed vertical blades]

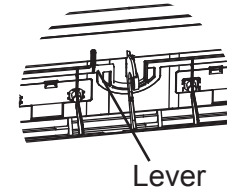
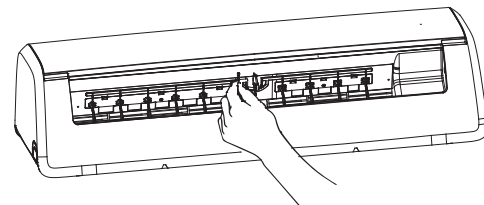

! WARNING!
Do not attempt this adjustment while the machine is in operation. Accidental contact with the fan may cause serious injury.

Step 4

Move the lever/s left or right to guide the air in the desired direction.

Step 5

ENERGISE the unit at the MAIN switch! (or plug back in)

Attention: Isolating the main power supply synchronises the

Louver position

Maximum down

In COOLING or DRY mode, condensate may form and drip from unit in high humidity condition.

Narrow opening

Restricted air flow reduces performance and may cause condensate.

Closed

Do not operate if it will not open – damage may occur.

Louver action

After a quick restart, louver may remain static for about 10s.



Features (Model dependent)

■ Auto swing of horizontal air flow*

- Press “SWING” for two seconds to engage vertical blades swing motion. Note: Please refer to the REMOTE CONTROLLER MANUAL for details.

■ Louver Memory*

Horizontal louver angle is memorised and will return to the position last selected by the user. This will not happen in TURBO mode, running by manual control buttons, or after a power interruption.

2.5 Special Functions

■ Compressor Delay

At start-up, a time delay of 3 ~ 5 minutes protects the compressor.

■ Auto Defrost*

Ice develops on the outdoor unit in heating mode. To defrost this ice, the indoor fan stops for a few minutes before heating continues.

■ Anti-cold*

To avoid uncomfortable when the air conditioner get into heating mode, the indoor unit will preheat before the fan starts. This delay should only last a few minutes.

■ Auto Restart*

The unit will automatically restart after a power interruption. Previous user settings are all recovered.

■ Auto Leak Detection*

When refrigerant leakage is detected, the unit will display “EC” or “ELOC” code or flash LEDs [model dependent].

■ Mildew Prevention*

This function keeps the indoor fan running in low speed for 7 minutes after being turned off by the user in cooling mode. Drying the water droplets on the indoor heat exchanger prevents mildew growth.

! CAUTION Interrupting this process may scramble the control logic. To reverse this, briefly disconnect the electrical supply.

■ WLAN Control*

With WLAN function, the unit can be controlled either by remote controller or by your mobile phone. Connect the WLAN module and communication module with display board to activate this function.

■ Air Purification* Ionizer*

Negative ions are added to the air to simulate the effects of forests and waterfalls on humans.

■ Plasma*

Dust particles in the passing air stream are charged electrically. This enhances dust collection, odour reduction and reduces airborne bacteria mortality.

■ Self Cleaning*

Airborne bacteria use the moisture on the indoor heat exchanger to grow. Regular drying of the exchanger prevents this growth. By simply pressing the “self clean” button, the controller will automatically manage the process.

■ Turbo*

The Turbo function makes the unit work extra hard to reach your present temperature in the shortest time possible.

[*] Model dependent.

3. CARE

Care and Maintenance

DISCONNECT from power source BEFORE attempting to clean or service!

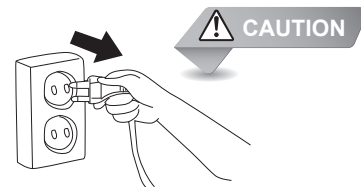

Filter Cleaning

1 Open the front panel by carefully lifting both ends at the same time. At a certain angle, a clicking sound is heard and it becomes self-supporting.

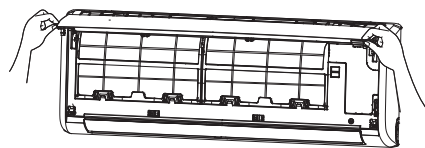

3 Unclip the small specialized filter.

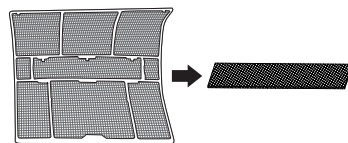

5 Vacuum clean the small filter/s. [Replace occasionally]

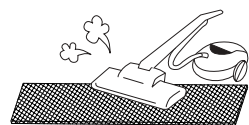

7 Re-insert into unit in the reverse order described in point 2 above.

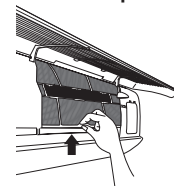

General Cleaning

Use a soft damp cloth when cleaning the grille, casing and remote controller.

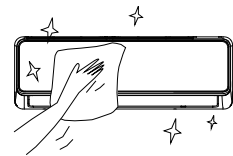

- No chemicals e.g. detergents, solvents, abrasive polish, etc,
- No heat (over 40°C)

2 Hold the tab on the filter to move it up a little, then pull slightly towards you. Now extract the filter by gently pulling it downwards.

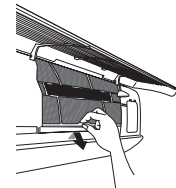

4 Clean the large air filter/s with soapy water. Rinse with fresh water. Shake off excess water.



6 Refit the small filter onto the large filter.

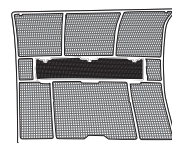

8 Close the front panel.

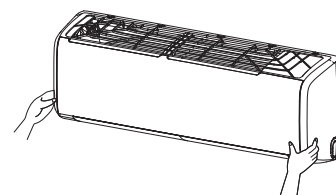

Storage Preparation [long idle periods]

- 1) Clean the air filters
- 2) In humid or damp climates, operate in Fan mode until the unit has dried out.
- 3) Turn the air conditioner off with the remote controller and remove the batteries.
- 4) Disconnect from the power source.

Re-use After Storage

- 1) Reconnect to the power source
- 2) Wait 24 hours when the ambient temperature is low (For inverter model).
- 3) Reinstall the batteries into the remote controller and turn the unit on.

Preventative Maintenance

Regularly check your unit for:

1. Obstructed airflow through the indoor and outdoor units.
2. Water or oil leaks.
3. Damaged or disconnected wires



Metal parts may have sharp edges that cause injury. Take care!

Regular high level maintenance of the indoor and outdoor units is essential.

- Specialist MAINTENANCE is required to do deep-clean, lubricate and function check of all critical components.
- Do not attempt such work by yourself.
- Contact a suitable service provider.

4. TROUBLE SHOOTING

Guides, Tips and Cautions

The following may occur during normal operation, and may not indicate malfunction.

Case	Explanation
Cooling or heating is delayed.	A 3 ~ 5 minutes delay protects the compressor.
Fan speed changes – off , very slow and then normal	Automatically happens in heating mode - prevents cold air blowing onto occupants.
The heating operation stops suddenly and defrost-light blinks.	Frost removal on outdoor unit is in progress (5 ~ 10mins).
Mist coming out of the indoor unit	May occur when unit temperature is low and room air is hot and humid.
Low volume sounds are emitted by the air conditioner	"Hissing": normal – gas pressure equalizing when compressor stops or starts.
	"Squeaking": normal expansion and contraction of plastic and metal parts.
	Rushing air – normal when louver resets its position.
Dust discharges from the unit.	May occur when air conditioner is used for the first time or has not been used for a long time.
Emits a peculiar odour.	Usually caused by chemicals, cigarette smoke, cooking etc. If not the case call your suitable contractor.
Changes to fan only while cooling or heating.	Room temperature is the same as that selected with the remote. If not the case call a suitable contractor.
Poor heating performance	May occur when outdoor temperatures are close to or below zero degrees Celsius.
	If not the case call a suitable contractor.
Turns on automatically	Normal when power is restored after a power failure.
Operation is erratic, unpredictable or unresponsive.	Interference from cell phone towers and remote boosters may cause the unit to malfunction.
	Disconnect the power and then re-connect.
	Press the ON/OFF button on the remote controller to restart operation.
	If the problem is not resolved call a suitable contractor.

The multi-system air conditioner can not be in different operating modes at the same time, such as one unit being in the "COOL" mode and one unit being in the "HEAT" mode. When conducting different operations, the "HEAT" mode will be given priority. The indoor unit which operates in "COOL" or "FAN" mode will stop and display "P5" or "--".

CONCERN	PLEASE FIRST CHECK!
Unit will not operate.	• Is there a power failure?
	• Has a switch been turned off, a circuit breaker tripped or a fuse blown?
	• Are the batteries in the remoter control fresh?
	• Are the clock and timer on the remote set correctly?
Not cool/warm enough.	• Are the temperature and mode settings correct?
	• Are the air filters clean?
	• Are the windows and doors closed?
	• Is air flow unrestricted in & out of indoor & outdoor units?
	• Is fan speed on high and louvers allowing maximum flow?

UNIT NOT RESPONDING AS REQUIRED?

- Record the product's model number,
- Contact a suitable contractor,
- Share all observed details!



In the case of ANY of the following, turn off the unit immediately!

- Power cord is damaged or abnormally warm.
- Burning odours are smelled.
- Loud or abnormal sounds are heard.
- A power fuse blows or a circuit breaker trips frequently.
- Water or other objects fall into or out of the unit.
- Indicators blink continuously.
- A self-diagnostic code is displayed and began with the letter as following: E(x),EL(xx),EH(xx),EC(xx) or P(x) ,PL(xx),PH(xx),PC(xx) etc.

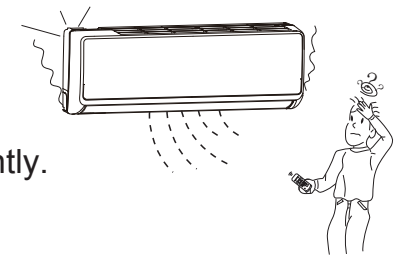

**DO NOT ATTEMPT TO CORRECT THESE ITEMS YOURSELF!
CONTACT A SPECIALIST SERVICE PROVIDER!**

图纸要求：

材质：双胶纸80g

尺寸：A3纸大度420*297对折为单页A4

封面封底双色套印，内页黑白。

封面套印开利蓝pantone 072 (C100, M85, Y0, K0)

商标叶子颜色pantone 376 (C50, M0, Y100, K0)